

Nevers is a veteran owned small business.

**GSA**  
**Simple™**

DELIVERED NET PRICING



**GENERAL SERVICES ADMINISTRATION**  
**Federal Supply Service**

**Authorized Federal Supply Schedule Catalog and Price List**

On-line access to contract ordering information, terms and conditions, up-to-date pricing and the option to create an electronic delivery order are available through GSA Advantage!™ a menu-driven database system. The INTERNET address for GSA Advantage!™ is:

<http://www.gsaadvantage.gov>

**Federal Supply Schedule for Office Furniture**  
**Schedule 71, Part 1**

**FSC Groups 7105, 7110, 7125, 7195**

**Contract Number: GS-28F-2052D**

For more information on ordering from Federal Supply Schedules click on the FSS Schedules button at <http://www.gsaadvantage.gov>

**Contract Period: February 24, 1996 through March 31, 2011**

# Simple™ general services administration information

## General Services Administration

Federal Supply Service  
Authorized Federal Supply Schedule Catalog & Price List  
On-line access to contract ordering information, terms and conditions, up-to-date pricing, and the option to create an electronic delivery order are available through GSA Advantage™, a menu-driven database system.

The INTERNET address for GSA Advantage™ is  
<http://www.GSAAdvantage.gov>  
Federal Supply Schedule for Office Furniture Schedule 71, Part 1  
FSC Groups 7105, 7110, 7125, 7  
Revision #6, Dated July 21, 2006195

## Contract Number

GS-28F-2052D  
For more information on ordering from Federal Supply Schedules click on the FSS Schedules button at <http://www.GSAAdvantage.gov>

## Contract Period

February 24, 1996 through March 31, 2011

## Contractor Name and Ordering Address

Nevers Industries, Inc.  
14125 21st Avenue North  
Minneapolis, MN 55447  
Phone: (800) 242-2443  
Fax: (763) 553-1770  
E-mail: [orders@nevers.com](mailto:orders@nevers.com)

## Information for Ordering Activities

Business Classification/Size: **Veteran Owned Small Business**

- 1a. Award Special Item Numbers:
  - 711-9 Executive Conference Room Furniture
  - 711-95 Installation Services
- 1b. Lowest price per SIN:711-9 = Model RPT = \$29.00
2. Order Limitation SIN:711-9 = \$100,000.00  
SIN:711-95 = \$500.00  
(any installation over \$500.00 must be negotiated prior to order placement).
3. Minimum order: \$100.00.
4. Geographic Coverage: 48 contiguous states, and the District of Columbia
5. Production Point: Minneapolis, MN.
6. Discount from List Price: Net – discount already deducted from list prices.
7. Volume Discounts: None.
8. Prompt Payment Discount: 1% - 20 days (from date of shipment), Net 30 days.
- 9a. Government Commercial Credit Card is accepted below the micropurchase threshold. (with no additional discounts).
- 9b. Government Commercial Credit Card is accepted above the micropurchase threshold. (with no additional discounts).
10. All items made in U.S.A.
- 11a. Time of Delivery: 60 days or less After Receipt of Order.
- 11b. Expedited Delivery: Quick Ship items available to ship in 10 working days. Larger orders will be subject to availability.
- 11c. Overnight and 2nd Day deliver: See 11b – Air or express freight, will calls and special delivery will be quoted and invoiced separately.
- 11d. Urgent Requirements: Call Factory.

12. FOB Destination. Freight is prepaid and allowed for normal ground transportation within the 48 contiguous states (minimum freight charge of \$50.00 applies to orders of less than \$1500.00 net per destination.) Air freight, will calls and special delivery will be quoted and invoiced separately. Prices do not include installation or sales tax. Nevers Industries, Inc. is not responsible for freight delays due to strikes, lockouts, weather, or other causes beyond our control.
13. Ordering Address:
  - Nevers Industries, Inc.
  - 14125 21st Avenue North
  - Minneapolis, MN 55447
  - Phone: (800) 242-2443
  - Fax: (763) 553-1770
  - E-mail: [orders@nevers.com](mailto:orders@nevers.com)
14. Payment Address: Same as #13 above.
15. Warranty: Nevers Industries, Inc. warrants its products to be free from defects in material and workmanship under normal and reasonable use and service for a period of ten years from date of shipment to customer. The decision of defects in workmanship or materials or the decision of misuse or abuse remains with Nevers Industries, Inc. No warranties other than those contained herein will be implied and Nevers Industries, Inc. does not authorize any person to create any warranties other than those contained herein.
16. Export Packing Charges: Quoted upon request.
17. Terms and Conditions of Government purchase card acceptance: upon invoicing.
18. Terms and Conditions of rental, maintenance and repair: N/A.
19. Terms and Conditions of installation: N/A.
20. Terms and Conditions of repair parts: N/A.
21. List of service and distribution points: N/A.
22. List of participating dealers: contact customer service for dealer listing.
23. Preventative maintenance: N/A.
24. Year 2000 (Y2K) compliant: Yes.
25. Environmental attributes: N/A.
26. Data Universal Number System (DUNS) number: 09-1732412  
Federal Id. Number: 41-1291670  
Cage Code Number: 02UD4
27. Nevers Industries, Inc. is registered in the Central Contractor Registration (CCR) database.

## Cancellation/Changes/Return Policy

No cancellation charges prior to production. After production, only actual costs incurred that cannot be recovered during a reasonable length of time (six months). Nevers Industries, Inc. will make every attempt to honor any reasonable change request provided that the request is received prior to start of production. Nevers Industries, Inc. reserves the right to increase our acknowledged price to make the requested changes. Merchandise may not be returned without the consent of Nevers Industries, Inc. and a Return Goods Authorization Form from Nevers' customer service department. If approved, the customer shall be responsible for a 25% restocking fee.

## Restock Policy

Merchandise may not be returned without the consent of Nevers Industries, Inc. and a Return Goods Authorization Form from Nevers' customer service department. If approved, the customer shall be responsible for a 25% restocking fee.

GSA Information .....	inside front cover
Collection features & benefits.....	1
Terms and conditions.....	2-3
General specifications .....	4-5
Power/voice/data/av (PVD) .....	6
Electrical system for conference tables.....	7
Simple™ articulating table tops and bases	
Arc boat tables.....	8
Connector table.....	8
Simple™ Meeting Link™ for articulating tables	
Specifications for preconfigured PVD .....	9
Specifications for each technology center.....	9
Technology center connectors.....	9
Table to floor connector.....	9
Connectivity and docking station for projector built into table base.....	9
Optional: direct wire routing from wall to table without core drilling .....	9
Simple™ conference table tops and bases	
Round tables.....	10
Meeting link for round tables with drum bases.....	10
Small rectangle tables.....	11
Meeting link for small rectangle tables.....	11
Rectangle tables.....	12
Arc rectangle tables.....	13
Boat tables.....	14
Arc boat tables.....	15
Racetrack tables .....	16
Viewpoint tables.....	17
Simple™ elements	
Storage credenzas/e-crenzas.....	18-19
Storage/display cabinets .....	18-19
Finishing tops.....	18
Buffet credenzas.....	19
Low credenzas .....	20
Wall mount buffet.....	20
Wall mount for flat screen monitor .....	20
Porcelain boards .....	20
Hospitality cart .....	21
Lectern.....	21
Visual boards .....	21
Simple™ preconfigured	
Storage credenzas.....	22-23
Buffet credenzas.....	22
Mediawalls.....	22
Storage/display cabinets.....	23

## Configured Your Way

That is the reason that Nevers introduced the Simple Collection. To allow you to easily specify the required product configurations and to easily specify multi-functional meeting and conferencing rooms with flexible products.

The key to Simple is interchangeable components in multiple sizes and finishes which perfectly suit any small enclave, team room, project room, full scale meeting or conference room.

It's also beautiful. Simple furniture is striking to look at in every finish and configuration. We build it to your specifications in the size, configuration, finish color, and base you select for the customers' space. Its design is cleanly contemporary and enduringly classic. Casegood tops and door fronts are offered in frosted glass, silver colorcoat and wood finishes. Table legs are produced in aluminum and wood and effectively house power cabling for the discreet containment of electrical and data cords. You can choose one piece or build entire rooms to your exact specifications knowing that the design is clean, current and capable.

## Conference Tables

The Simple Conference Tables are stylized in a cleanly contemporary design that complements any design format. The support structure allows all cabling for power and AV to be installed prior to the table top being attached. This eliminates damage to the top during installation and significantly reduces the complexity of cable routing and installation time.

## Casegoods

Casegoods represent the ultimate form of multiplicity from simplicity. The collection consists of multiple versions of single wide and double wide cabinets that can be specified in an unlimited number of configurations with varying door materials and cabinet top options. The cabinets are designed to be specified and used in two ways. The first is as modular furniture. The cabinets may be specified as stand-alone modules that are simply butted together at installation to form the required piece – credenza, mediawall, storage tower. Modular cabinets enhance the contemporary styling of the space and allow the end user maximum flexibility for future growth, such as reconfiguring the room or using the cabinets in other rooms.

Secondly, the Simple cabinets may be specified with a common connecting top. This maintains the ease of configuring the cabinets to the customers' requirement, while presenting a more traditional single piece furniture appearance. For ease of specifying, the Simple cabinets are also offered as preconfigured cabinets in the most commonly requested configurations. It's simple, and it's specification-friendly. If you are in a hurry, let us plan the room for you with individual pieces specified and floor-planned in multi-application formats. That's simple too.

The Simple Casegoods are offered in two depths. The 16" depth is the preferred cabinet for smaller rooms. The 22" depth is scaled for larger rooms and rooms requiring AV components and power accommodations. The double wide 22" deep e-cabinets are vented and ready to accept a rack mount for AV components. For simplicity in ordering and security for the end user, cabinets are standard with locks. Locks are not available on glass door cabinets.

As an added bonus, you will find the furniture in the Simple Collection to be competitively priced. The Simple Collection maintains our reputation for "high quality product designs, crafted only with the highest qualities of material and workmanship and delivered trouble-free as promised." It is through design engineering that we are able to offer the Simple Collection at surprisingly competitive pricing.

### **Credit and Payment Terms**

Nevers Industries Inc. policy does not allow for automatic open account terms for new customers, customers whose account is not current, individuals or residential accounts. *New customers are required to make a deposit for the full value of the merchandise ordered.* A credit application will be sent to each new customer. Credit will be established upon review of the responses given by the customer's references and will appear on future order acknowledgments. New customers are encouraged to begin establishing a credit rating with Nevers Industries Inc. prior to placing an order. Our customers are responsible to provide the necessary current and accurate information. *Upon establishment of an open account, terms are Net 30. 1 1/2% per month service charge will be added to all past due accounts. Accounts that are 90 days past due will be subject to collection proceedings without any additional notice. Orders will not be processed for past due accounts until the amount due, including any service charges, is paid in full.* Standard product orders exceeding \$50,000 net will require a down payment of 33%. Custom orders will require a down payment of 50% and will not be scheduled for production until the down payment is received. Balance is then due before shipment. *A bank letter of credit may be required for any order over \$50,000 net.*

### **Prices**

Our prices are list, freight prepaid, F.O.B. Plymouth, Minnesota, and are subject to change without notice. Quoted prices must be accepted within 30 days or re-quoted for date and approval. Freight is prepaid and allowed for normal ground transportation within the 48 contiguous states, must ship to dock location. Air freight, will calls, and special delivery will be quoted and invoiced separately. Prices do not include installation, storage, or sales tax.

### **Packaging**

Nevers Industries, Inc. pricing includes packing for North American shipment. Whenever possible, Nevers will blanket-wrap your order; otherwise, all products will be packaged. Only environmentally safe packing materials are used. Large furniture pieces will be packed with wood reinforcements for added protection. For special packaging, crating or overseas shipment, please contact our Customer Service Department.

### **Delivery**

Nevers Industries, Inc. will select the method of shipment, carrier and routing. Carrier selection is solicited to provide the best service to each customer in their particular location. All shipments are sent prepaid, F.O.B. Plymouth, Minnesota. *Nevers Industries, Inc. liability ends when the carrier issues a receipt to Nevers Industries, Inc. This is an acknowledgement by the*

*transportation company that the shipment has been received by the freight company in good condition and title of the goods and risk of loss transfers to the buyer. The order shall be considered complete. Prepaid freight does not change the F.O.B. status of the product and risks involved in the shipment. We reserve the right to make partial shipments.* Invoices relevant to the partial shipments are payable as they fall due.

### **Freight Terms**

All orders under \$2,000 net are subject to a minimum order/additional freight charge of \$100 net; Nevers Industries, Inc. also reserves the right to establish a freight and fuel surcharge fee to cover variable freight costs. This charge will be established at the time of order and acknowledgement date.

### **Lead Times**

The lead time on an order begins when Nevers' Order Entry Department has verified the validity of the items ordered and has received at our manufacturing facility all COM materials supplied by others. All acknowledgements will contain current lead time information. If for some reason the buyer does not want the order early, please list a Do Not Ship before date. We are not responsible for delays in scheduling or failure to make scheduled shipping date due to strikes, lockouts or other labor complications, war, riots, Acts of God, fires, accidents, restraints affecting shipment or credit, reduced supply or excessive cost of fuel or raw material, delays from suppliers, compliance with Government regulations, or other unforeseen contingencies. When delays in product delivery are caused by the purchaser, we reserve the right to draw up to 100% of the contract price and to charge to the purchaser any costs incurred by us due to such.

### **Order Acknowledgement**

All orders are subject to final acceptance by Nevers Industries, Inc. Receipt of our acknowledgement indicates acceptance of your order subject to the terms and conditions set forth in Our Acknowledgement. If pricing on the purchase order is different than the acknowledged pricing, the acknowledgement will take precedent over the purchase order. Nevers Industries, Inc. attempts to clarify all orders. But in the event of any discrepancy, please notify Nevers Industries, Inc. immediately. Failure to notify Nevers of a discrepancy within five (5) days will constitute acceptance of the order as acknowledged. All orders are subject to credit approval at any time.

### **Change Orders**

Nevers Industries, Inc. will make every attempt to honor any reasonable change request to standard product provided that the request is received prior to start of production. Change orders will be accepted only if the request is made in writing

and is received in time to make the change. Nevers Industries, Inc. reserves the right to increase our acknowledged price and ship date if necessary to make the requested changes. Nevers Industries, Inc. will make every reasonable effort to stop production, scheduling shipments, etc., upon receipt of written notification of changes, cancellations, or deferments of delivery. Nevers will assess charges to the customer for change orders, cancellations, and delivery deferments as stipulated in the following:

#### Change Orders:

- Received prior to start of production will be charged \$200 net.
- Received changes after production has started involving design changes or reductions in quantity will not be accepted. The customer will receive the goods as ordered and be liable for the amount due.

#### Cancellations:

- Received prior to start of production will be assessed a \$500 net cancellation charge.
- Received after production has started will be assessed the total accumulated cost of the project plus a \$500 net cancellation charge.

#### Deferred Shipments

All merchandise will ship upon completion of production. If customer is unable to take delivery of merchandise when ready for shipment, Nevers Industries, Inc. may transfer the merchandise to storage. All cost for storage and freight will be at customer's expense. Transfer to storage will be considered delivery for all purposes including invoicing and payment. Customer will bear the risk of loss or damage during storage. Deferred shipment charges will be assessed from the completion date in accordance with Nevers policy for Storage by the Manufacturer.

#### Storage By The Manufacturer

No shipment can be postponed by the customer. Nevers Industries, Inc. reserves the right to transfer products to storage and issue its invoice for the products at that time. Such transfer to storage shall be deemed delivery to the customer for all purposes. Long term storage over 30 days may be subject to surcharges.

#### Shipment Claims

Legal title of merchandise passes to the buyer upon acceptance by the carrier. The buyer must inspect all cartons on arrival for visible or concealed damage. In the event of visible freight damage, the buyer must make a notation on the freight bill; immediately notify the carrier for an inspection; and file a freight claim. *Do not sign the receipt until the visual inspection is*

*complete at the time of delivery. If concealed damage is discovered, the carrier must be notified within 15 days.* Keep all packaging materials for inspection (do not destroy). The buyer has the sole obligation of seeking recourse against the carrier. Caution: When a clear receipt is obtained by a carrier, the carrier is no longer responsible for damages or shortages. Damaged freight cannot be refused by the consignee (buyer). Processing claims for damages and shortages are the responsibility of the buyer. At no time can claims be deducted from our invoices.

#### Returns

All Nevers Industries, Inc. products are made to order. Therefore, merchandise may not be returned without specific consent from Nevers Customer Service Department. Unauthorized returns will be refused by the shipping department.

#### Miscellaneous

All merchandise shown in our catalog is the property of Nevers Industries, Inc. We reserve the sole right to manufacture and distribute it. All patterns, tools, and designs developed for the production of any product will remain the property of Nevers Industries, Inc. All published dimensions are approximate and if the exact sizes are critical, we suggest that you request actual measurements. Price list data supersedes all other specifications, whether verbal or written, and may not be altered without the written consent of an officer of Nevers Industries, Inc. Typing and clerical errors on any agreement, publication, correspondence, price list, or product literature pieces are subject to correction at any time without notice. Due to variations beyond our control, all wood and upholstery products are subject to slight variations in color, texture, and grain.

#### Specifications

Nevers Industries, Inc. reserves the right to change prices, specifications, fabrics, dimensions and finishes at any time without prior notice. This right to change also applies to discontinuing models at any time, catalog contents and price list contents.

#### Warranty

Nevers Industries, Inc. warrants its products to be free from defects in material and workmanship under normal and reasonable use and service for a period of ten years from the date of shipment to customer. Proprietary supporting products, which are manufactured by others and sold by Nevers Industries, Inc. carry the original manufacturer's warranty. The decision of defects in workmanship or materials or the decision of misuse or abuse remains with Nevers Industries, Inc. No warranties other than those contained herein will be implied and Nevers Industries, Inc. does not authorize any person to create any warranties other than those contained herein.

**AWI "A" Grade Wood Veneers**

Simple products are crafted in "A" grade wood veneers available in Mahogany, Black Walnut, White Oak, Cherry, Maple and Ash. Veneer panels are 3-ply balanced construction, are laid up with plain sliced face veneers and are balanced on back to minimize warping and to balance natural stresses. Cores are either 45# particleboard, or 55# medium density fiberboard, per ANSI standards 208.1 or 208.2. Face veneers meet or exceed AWI custom standards and are "A" grade. All "A" grade face veneers are center matched and either book or slip matched and are laid up to Nevers' custom specifications.

**Wood Veneer Finishes**

Standard wood veneer finishing process is a multi-step procedure involving dyes, stains, toners, sealers, lacquer. For added protection and durability, the final topcoat on all horizontal surfaces is a catalyzed-blended, lacquer/varnish finish. All finishing processes have been formulated to provide maximum durability and clarity, and to enhance the natural characteristics of each particular wood species. Standard finish is open pore. Semi-filled and filled finishes require an up charge and may extend the lead-time. Please contact Customer Service for pricing and availability on these and other wood species.

Note: Color variation will occur in the grain of all wood species. This is an inherent characteristic caused by the annual growth rings found in all hardwoods and by the manner in which the boards and veneers are cut across these growth rings. In some species, this color variation is very subtle. In other species this color variation is obvious and at times radical.

The process of finishing hardwood veneers determines whether these variations are enhanced or subdued. Natural finishes will show color variations in the grain and enhance the beauty of the wood to its fullest extent. Other stains, toners, and finishes tend to blend these variations, dependent upon the depth of color and the particular method of application.

**Color Index for AWI "A" Grade Wood Veneers**

**Wood Species and Colors**

**Oak**

Natural Oak	NO
Medium Oak	MO
Dark Oak	DO
Ebony on Oak	EO

**Walnut**

American Walnut	AW
Dark Walnut	DW
Mahogany on Walnut	MW
Presidential Walnut	PW
Espresso Walnut	EW

**Mahogany**

Light Mahogany	LM
Brown Mahogany	BM
Dark Mahogany	DM

**Cherry**

Natural Cherry	NC
Amber Cherry	AC
Brown Cherry	BC
Medium Cherry	MC
Dark Cherry	DC
Espresso Cherry	PC
Cinnamon Cherry	CC

**Maple**

Natural Maple	NP
Golden Maple	GP
Copper Maple	PP
Autumn Maple	TP
Honey Maple	YP
Ebony Maple	EP

**Ash**

Cocoa Ash	CA
Natural Ash	NA

### **Custom Wood Colors and Finishes**

Nevers offers the capability of matching your custom stains or finishes. Virtually any wood finish or color sample can be matched to your specifications. A finish or stain sample is required before the process of matching approval can begin. The upcharge of custom finishes varies with the type of finish and also with the quantity ordered. Please contact Customer Service for pricing and availability. For custom stain/color match – any order under \$5,000 list there is a list \$270 net upcharge. Engineered wood veneers cannot be customer stained.

### **Engineered Wood Veneers**

Simple products may also be specified in engineered wood veneers in patterns and colors of Natural Maple and natural Cherry. Standard wood finishing process for engineered veneers is a multi-step procedure involving sealers and lacquer. For added protection and durability, the final topcoat on all horizontal surfaces is a catalyzed-blended, lacquer/varnish finish. All finishing processes have been formulated to provide maximum durability and clarity, and to enhance the characteristics of each wood pattern. Standard finish is open pore. Semi-filled and filled finishes require an upcharge and may extend the lead time. Please contact Customer Service for pricing and availability on these and other engineered wood patterns.

### **ColorCoat**

Standard ColorCoat is a painted wood core of 48# medium density fiberboard, per ANSI standards 208.1 or 208.2. Special colors are available and may require an upcharge and extend lead-time. Please contact Customer Service for pricing and availability.

### **Optional Glass Tops**

Credenza glass tops are 3/8" thick and are etched on the back for a semi-transparent appearance. Optional adjustable glass shelves are clear. Optional buffet shelf glass tops are 1/2" thick and are etched on the back for a semi-transparent appearance. HydroShield™ fingerprint protectant can be applied for \$16 per square foot. Call Customer Service for details.

### **ColorCoat and Metal Colors**

Simple products ship standard with Silver Fog ColorCoat and Platinum metal. For other colors please contact our Customer Service Department at 800-242-2443.

### **Fabric Color for Visual Boards**

Any C.F. Stinson-Pattern "Mira" series may be specified. If not specified, ships standard with Shadow.

### **Furniture Care, Cleaning and Maintenance Instructions WOOD SURFACES**

Your Nevers' furniture requires only minimal care to ensure years of lasting beauty and performance. Any spilled liquids should be wiped up immediately with a dry, soft cloth. On a weekly basis, dust the wood surface, then clean with a damp, soft cloth, wiping in the direction of the wood grain. Surface should then be dried with a dry, soft cloth. On a semi-annual basis, after the weekly cleaning, clean the wood surfaces with a quality wood cleaner such as Guardsman Wood Cleaner. Products containing oil, ammonia or silicon should not be used. For specific questions about Furniture Care, Cleaning and Maintenance, contact Nevers Customer Service at 800-242-2443.

### UNDERSTANDING NEVERS MEETING LINK™

The Nevers Meeting Link System is comprised of Technology Centers and Power Centers.

#### Technology Centers

Technology Centers conform to UL 183, 20 AMP plug and is the standard for manufactured electrical systems. Nevers proprietary Technology Centers use modular power connections, are daisy-chainable and are ideal for all installations where multiple electrical outlets connect to a single power in-feed. They are available in single or multiple circuits. Technology Centers can be hardwired or connected with a molded plug. Data and AV are easily integrated in Technology Centers.

**INSTALLATION:** Technology Centers are installed in the table base system before the top is placed. This provides electrical, data and audio visual contractors a convenient, well lit work area. The table top is placed on the base system after technology integration is complete. This helps prevent table top damage attributable to third party contractors.

#### Power Centers

Power Centers conform to UL962A, the standard for furniture power distribution units. Power centers connect directly to a power outlet with a molded plug. Power Centers are a flexible, cost effective solution for mobile or light duty applications. Power Centers do not connect in series. Data and basic AV connections are easily integrated in Power Centers.

**INSTALLATION:** Power Centers drop through the table top. They are the last part of the table to be installed. This is a quick and simple installation process for light duty power/voice/data applications.

#### Pre-Configured Meeting Link™

Nevers offers pre-configured Meeting Link solutions for all tables. This is an easy, trouble-free method to specify power, voice and data connections. Whether you have light, medium or heavy applications, there is a convenient pre-configured solution.

#### Custom Meeting Link™

Meeting Link can be custom configured to meet any specific requirement. All Meeting Link products are available a la carte so you can develop a system that meets your clients exact needs.

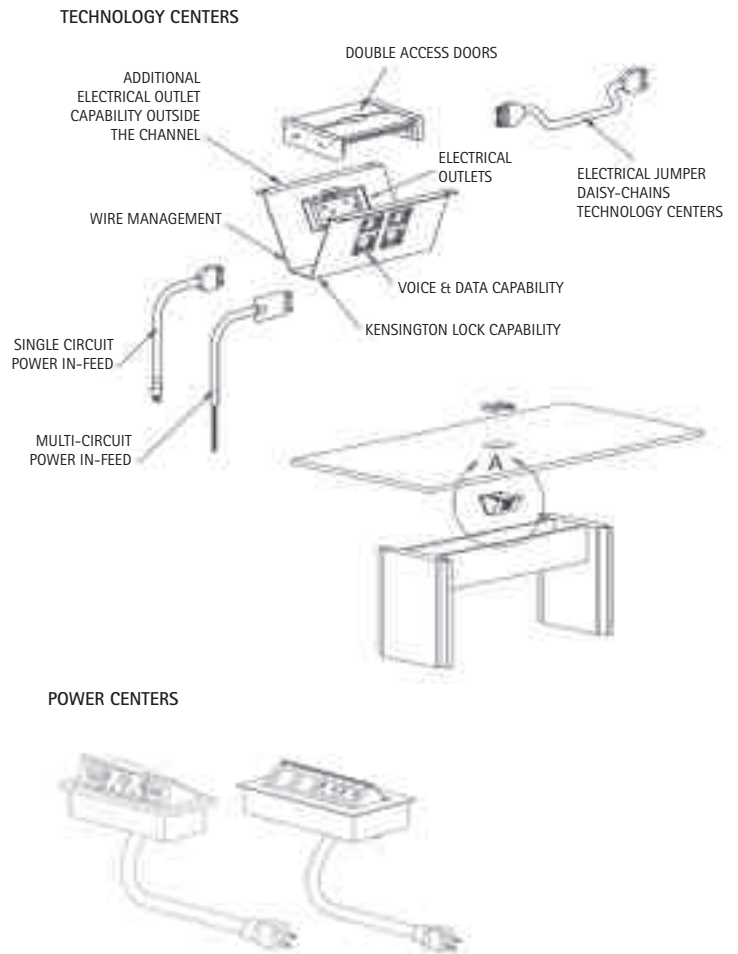

**Preconfigured Meeting Link™ System 3: Light Capacity**  
 Technology Center Dimensions: 8"l x 6"w



Table Length	Number of Technology Centers	Electrical Outlets	Voice, Data and AV Port Capacity
8'	1	2	6
10'	1	2	6
12'	2	4	12
14'	2	4	12
16'	2	4	12
18'	2	4	12
20'	3	6	18
22'	3	6	18
24'	3	6	18
26'	4	8	24

**Technology Centers for Customizing Meeting Link™ Capabilities**  
 Please note - location drawing required\*

Technology Center Dimension	Number of Electrical Outlets	Voice, Data and AV Port Capacity
8"l x 6"w	2	6
12"l x 6"w	2	6

\* A drawing of the table top with the location of each Technology Center is required. If ordering multiple Technology Centers for 1 table, specify on drawing if ganging is required. For additional assistance in specifying/ordering Technology Centers, please contact customer service at 800.242.2443.

# Simple™ articulating table tops and bases

## arc boat tables



48" wide x 39" wide ends			wood projector end with silver metal C leg	modesty panels 12" high MP	meeting link for full table O3	meeting link for presentation end only O2
Length	Size	Model Number	Price	Price	Price	Price
8'	96" x 48"	M/E1/TAO/09648	\$ 4,277	\$ 786	\$ 974	\$ 325
10'	120" x 48"	M/E1/TAO/12048	4,592	832	974	325
12'	144" x 48"	M/E1/TAO/14448	5,053	969	974	325
14'	168" x 48"	M/E1/TAO/16848	5,953	1,097	1,624	325

## connector table

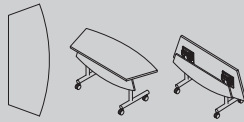

stationary top			wood projector end with silver metal C leg	modesty panels 12" high MP
Length	Size	Model Number	Price	Price
4'	48" x 24"	M/E1/TCO/04824/ST	\$ 1,018	\$ 379
5'	60" x 24"	M/E1/TCO/06024/ST	1,075	417
6'	72" x 24"	M/E1/TCO/07224/ST	1,138	441

## flip top

4'	48" x 24"	M/E1/TCO/04824/FT	\$ 1,395	\$ 379
5'	60" x 24"	M/E1/TCO/06024/FT	1,473	417
6'	72" x 24"	M/E1/TCO/07224/FT	1,550	441

## how to order

please specify	example
1. model number	M/TAO/16848
2. wood color	DC
3. optional modesty panel	MP
4. optional power/voice/data	O3

notes:

see page 7 for wood colors

see page 9 for power/voice/data specifications

# Simple™ Meeting Link™ for articulating tables

specifications for preconfigured power/voice/data

table length	full table technology centers quantity	presentation end only technology centers quantity	table seating capacity length	closed capacity	open capacity	with connector table capacity
8'	3	1	8'	8	7	10
10'	3	1	10'	10	9	12
12'	3	1	12'	12	11	14
14'	3	1	14'	14	13	16

## specifications for each technology center

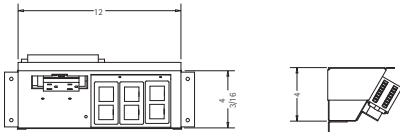

Dimensions: 12"l x 6"w

Number of outlets: two (2)

Voice/data/av connectors: capacity for up to 6 connectors

Technology center for presentation end includes: access grommet for connection to projector and permanent cord storage

Cover is brushed aluminum

## technology center connectors



Electrical jumper connects the technology centers

## table to floor connector



Single circuit power in-feed from table to floor with soft cord plug-in

## connectivity and docking station for projector built into table base

When ordered with any meeting link™ option



Projector mounts in base to allow immediate access. Easy table top connectivity for notebooks.

## optional: direct wire routing from wall to table without core drilling (ADA approved)



Cross Section

For specifying/pricing: call Nevers' customer service 1.800.242.2443 or visit [www.connectrac.com](http://www.connectrac.com)

# Simple™ conference table tops and bases

round tables



diameter		drum base DB	metal base BS	metal base BT	meeting link power/ voice/data 03
size	model number	price	price	price	price
42" dia	M/TA1/04200	\$ 1,220	\$ 1,008	\$ na	\$ 261
48" dia	M/TA1/04800	1,449	1,236	na	261
54" dia	M/TA1/05400	1,634	na	1,534	261
60" dia	M/TA1/06000	1,864	na	1,765	261
72" dia	M/TA1/07200	2,105	na	na	261

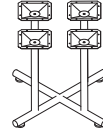
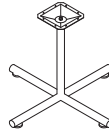
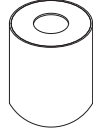

## meeting link for round tables with drum bases

size	model number	number of power centers	electrical outlets	voice, data and av port capacity	price
42" dia	R/PC3/01	1	2	2	\$ 261
48" dia	R/PC3/01	1	2	2	261
54" dia	R/PC3/01	1	2	2	261
60" dia	R/PC3/01	1	2	2	261
72" dia	R/PC3/01	1	2	2	261



### General Specifications:

1. Power in-feed is soft cord plug in.
2. For Meeting Link for metal bases, contact Customer Service.
3. Door frame is clear anodized aluminum.

When ordering please specify order number.

## how to order

please specify	example
1. model number & base code	M/TA1/06000/DB
2. wood color	DC
3. optional power/voice/data	03

notes:

see page 7 for wood colors

see page 9 for power/voice/data specifications

# Simple™ conference table tops and bases

## small rectangle tables



30" wide			metal base MQ	metal base MR	meeting link power/ voice/data O3
length	size	model number	price	price	price
4'	48" x 30"	M/TB1/04830	\$ 1,171	\$ na	\$ 261
5'	60" x 30"	M/TB1/06030	1,321	na	261
6'	72" x 30"	M/TB1/07230	1,359	na	261

## 36" wide

6'	72" x 36"	M/TB1/07236	\$ 1,549	\$ na	\$ 261
7'	84" x 36"	M/TB1/08436	1,623	na	261

## 42" wide

6'	72" x 42"	M/TB1/07242	\$ na	\$ 1,623	\$ 261
7'	84" x 42"	M/TB1/08442	na	1,784	261

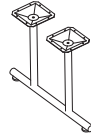

## meeting link for small rectangle tables

top length	model number	number of power centers	electrical outlets	voice, data and av port capacity	price
4'	R/PC3/01	1	2	2	\$ 261
5'	R/PC3/01	1	2	2	261
6'	R/PC3/01	1	2	2	261
7'	R/PC3/01	1	2	2	261



### General Specifications:

1. Power in-feed is soft cord plug in.
2. Door frame is clear anodized aluminum.
3. 2" grommet - round R/GRM \$44

When ordering please specify order number.

## how to order

please specify	example
1. model number & base code	M/TB1/08436/MR
2. wood color	DC
3. optional power/voice/data	O3

### notes:

see page 7 for wood colors

see page 9 for power/voice/data specifications

# Simple™ conference table tops and bases

rectangle tables



			half panel bases HB	panel bases PB	rectangle bases RB	combination half panel/ bases HP	combination panel/ rectangle bases PR	optional power/voice/data O3
<b>48" wide</b>								
length	size	model number	price	price	price	price	price	price
8'	96" x 48"	M/TC1/09648	\$ 2,563	\$ 2,346	\$ 2,462	\$ na	\$ na	\$ 325
10'	120" x 48"	M/TC1/12048	2,920	2,702	2,837	na	na	325
12'	144" x 48"	M/TC1/14448	3,713	3,386	3,555	3,620	3,504	650
14'	168" x 48"	M/TC1/16848	4,106	3,779	3,967	4,003	3,911	650
16'	192" x 48"	M/TC1/19248	4,499	4,172	4,380	4,386	4,317	650
18'	216" x 48"	M/TC1/21648	4,892	4,564	4,792	4,769	4,724	650
20'	240" x 48"	M/TC1/24048	5,685	5,248	5,510	5,542	5,432	974
22'	264" x 48"	M/TC1/26448	6,078	5,641	5,923	5,926	5,838	974
24'	288" x 48"	M/TC1/28848	6,471	6,034	6,335	6,309	6,245	974
26'	312" x 48"	M/TC1/31248	6,863	6,427	6,748	6,691	6,652	1,299
<b>54" wide</b>								
8'	96" x 54"	M/TC1/09654	\$ 2,843	\$ 2,610	\$ 2,741	\$ na	\$ na	\$ 325
10'	120" x 54"	M/TC1/12054	3,244	3,011	3,162	na	na	325
12'	144" x 54"	M/TC1/14454	4,111	3,762	3,950	4,009	3,894	650
14'	168" x 54"	M/TC1/16854	4,552	4,203	4,413	4,438	4,350	650
16'	192" x 54"	M/TC1/19254	4,992	4,643	4,876	4,868	4,806	650
18'	216" x 54"	M/TC1/21654	5,433	5,083	5,338	5,297	5,262	650
20'	240" x 54"	M/TC1/24054	6,300	5,834	6,126	6,143	6,038	974
22'	264" x 54"	M/TC1/26454	6,740	6,275	6,588	6,572	6,494	974
24'	288" x 54"	M/TC1/28854	7,181	6,715	7,051	7,001	6,950	974
26'	312" x 54"	M/TC1/31254	7,621	7,156	7,513	7,431	7,406	1,299
<b>60" wide</b>								
8'	96" x 60"	M/TC1/09660	\$ 3,059	\$ 2,826	\$ 2,967	\$ na	\$ na	\$ 325
10'	120" x 60"	M/TC1/12060	3,482	3,249	3,412	na	na	325
12'	144" x 60"	M/TC1/14460	4,371	4,021	4,222	4,261	4,162	650
14'	168" x 60"	M/TC1/16860	4,832	4,483	4,707	4,712	4,640	650
16'	192" x 60"	M/TC1/19260	5,294	4,945	5,192	5,162	5,118	650
18'	216" x 60"	M/TC1/21660	5,756	5,407	5,439	5,612	5,596	650
20'	240" x 60"	M/TC1/24060	6,644	6,179	6,488	6,478	6,395	974
22'	264" x 60"	M/TC1/26460	7,106	6,640	6,972	6,928	6,873	974
24'	288" x 60"	M/TC1/28860	7,568	7,102	7,457	7,378	7,350	974
26'	312" x 60"	M/TC1/31260	8,029	7,564	7,942	7,829	7,829	1,299

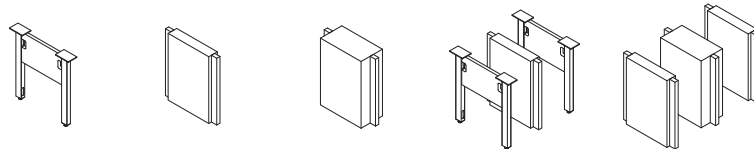

## how to order

## combination base configurations

please specify	example	table length	half panel/panel bases	panel/rectangle bases
1. model number & base code	M/TC1/16860/PR	12' - 18'	2 half panel & 1 panel	2 panel & 1 rectangle
2. wood color	DC	20' - 24'	2 half panel & 2 panel	2 panel & 2 rectangle
3. optional power/voice/data	O3/HW	26'	3 half panel & 2 panel (alternating half panel/panel)	3 panel & 2 rectangle (alternating panel/rectangle)
notes:				
see page 7 for wood colors				
see page 9 for power/voice/data specifications				

# Simple™ conference table tops and bases

arc rectangle tables



			half panel bases HB	panel bases PB	rectangle bases RB	combination half panel/ bases HP	combination panel/ rectangle bases PR	optional power/voice/data O3
<b>48" wide</b>								
length	size	model number	price	price	price	price	price	price
8'	96" x 48"	M/TD1/09648	\$ 2,692	\$ 2,462	\$ 2,585	\$ na	\$ na	\$ 325
10'	120" x 48"	M/TD1/12048	3,066	2,837	2,979	na	na	325
12'	144" x 48"	M/TD1/14448	3,899	3,555	3,733	3,801	3,679	650
14'	168" x 48"	M/TD1/16848	4,311	3,967	4,166	4,203	4,107	650
16'	192" x 48"	M/TD1/19248	4,724	4,380	4,599	4,606	4,533	650
18'	216" x 48"	M/TD1/21648	5,136	4,792	5,032	5,008	4,960	650
20'	240" x 48"	M/TD1/24048	5,969	5,510	5,786	5,819	5,704	974
22'	264" x 48"	M/TD1/26448	6,381	5,923	6,219	6,222	6,131	974
24'	288" x 48"	M/TD1/28848	6,794	6,335	6,652	6,624	6,557	974
26'	312" x 48"	M/TD1/31248	7,206	6,748	7,085	7,026	6,984	1,299
<b>54" wide</b>								
8'	96" x 54"	M/TD1/09654	\$ 2,985	\$ 2,741	\$ 2,877	\$ na	\$ na	\$ 325
10'	120" x 54"	M/TD1/12054	3,407	3,162	3,320	na	na	325
12'	144" x 54"	M/TD1/14454	4,317	3,950	4,148	4,209	4,089	650
14'	168" x 54"	M/TD1/16854	4,780	4,413	4,634	4,660	4,568	650
16'	192" x 54"	M/TD1/19254	5,242	4,876	5,119	5,111	5,046	650
18'	216" x 54"	M/TD1/21654	5,704	5,338	5,605	5,562	5,525	650
20'	240" x 54"	M/TD1/24054	6,615	6,126	6,432	6,450	6,341	974
22'	264" x 54"	M/TD1/26454	7,078	6,588	6,918	6,901	6,819	974
24'	288" x 54"	M/TD1/28854	7,540	7,051	7,403	7,351	7,298	974
26'	312" x 54"	M/TD1/31254	8,002	7,513	7,889	7,802	7,776	1,299
<b>60" wide</b>								
8'	96" x 60"	M/TD1/09660	\$ 3,212	\$ 2,967	\$ 3,116	\$ na	\$ na	\$ 325
10'	120" x 60"	M/TD1/12060	3,656	3,412	3,582	na	na	325
12'	144" x 60"	M/TD1/14460	4,589	4,222	4,433	4,474	4,370	650
14'	168" x 60"	M/TD1/16860	5,074	4,707	4,943	4,947	4,872	650
16'	192" x 60"	M/TD1/19260	5,559	5,192	5,452	5,420	5,374	650
18'	216" x 60"	M/TD1/21660	6,044	5,677	5,961	5,892	5,875	650
20'	240" x 60"	M/TD1/24060	6,976	6,488	6,812	6,802	6,715	974
22'	264" x 60"	M/TD1/26460	7,461	6,972	7,321	7,275	7,216	974
24'	288" x 60"	M/TD1/28860	7,946	7,457	7,830	7,748	7,718	974
26'	312" x 60"	M/TD1/31260	8,431	7,942	8,339	8,220	8,220	1,299

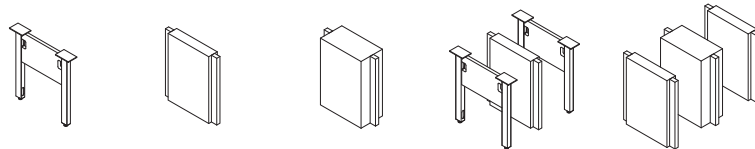

## how to order

please specify	example
1. model number & base code	M/TD1/16860/PR
2. wood color	DC
3. optional power/voice/data	O3

notes:

see page 7 for wood colors

see page 9 for power/voice/data specifications

## combination base configurations

table length	half panel/panel bases	panel/rectangle bases
12' - 18'	2 half panel & 1 panel	2 panel & 1 rectangle
20' - 24'	2 half panel & 2 panel	2 panel & 2 rectangle
26'	3 half panel & 2 panel (alternating half panel/panel)	3 panel & 2 rectangle (alternating panel/rectangle)

# Simple™ conference table tops and bases

boat tables



			half panel bases HB	panel bases PB	rectangle bases RB	combination half panel/ bases HP	combination panel/ rectangle bases PR	optional power/voice/data O3
<b>48" wide</b>								
length	size	model number	price	price	price	price	price	price
8'	96" x 48"	M/TE1/09648	\$ 2,692	\$ 2,462	\$ 2,585	\$ na	\$ na	\$ 325
10'	120" x 48"	M/TE1/12048	3,066	2,837	2,979	na	na	325
12'	144" x 48"	M/TE1/14448	3,899	3,555	3,733	3,801	3,679	650
14'	168" x 48"	M/TE1/16848	4,311	3,967	4,166	4,203	4,107	650
16'	192" x 48"	M/TE1/19248	4,724	4,380	4,599	4,606	4,533	650
18'	216" x 48"	M/TE1/21648	5,136	4,792	5,032	5,008	4,960	650
20'	240" x 48"	M/TE1/24048	5,969	5,510	5,786	5,819	5,704	974
22'	264" x 48"	M/TE1/26448	6,381	5,923	6,219	6,222	6,131	974
24'	288" x 48"	M/TE1/28848	6,794	6,335	6,652	6,624	6,557	974
26'	312" x 48"	M/TE1/31248	7,806	6,748	7,085	7,026	6,984	1,299
<b>54" wide</b>								
8'	96" x 54"	M/TE1/09654	\$ 2,985	\$ 2,741	\$ 2,877	\$ na	\$ na	\$ 325
10'	120" x 54"	M/TE1/12054	3,407	3,162	3,320	na	na	325
12'	144" x 54"	M/TE1/14454	4,317	3,950	4,148	4,209	4,089	650
14'	168" x 54"	M/TE1/16854	4,780	4,413	4,634	4,660	4,568	650
16'	192" x 54"	M/TE1/19254	5,242	4,876	5,119	5,111	5,046	650
18'	216" x 54"	M/TE1/21654	5,704	5,338	5,605	5,562	5,525	650
20'	240" x 54"	M/TE1/24054	6,615	6,126	6,432	6,450	6,341	974
22'	264" x 54"	M/TE1/26454	7,078	6,588	6,918	6,901	6,819	974
24'	288" x 54"	M/TE1/28854	7,540	7,051	7,403	7,351	7,298	974
26'	312" x 54"	M/TE1/31254	8,002	7,513	7,889	7,802	7,776	1,299
<b>60" wide</b>								
8'	96" x 60"	M/TE1/09660	\$ 3,212	\$ 2,967	\$ 3,116	\$ na	\$ na	\$ 325
10'	120" x 60"	M/TE1/12060	3,656	3,412	3,582	na	na	325
12'	144" x 60"	M/TE1/14460	4,589	4,222	4,433	4,474	4,370	650
14'	168" x 60"	M/TE1/16860	5,074	4,707	4,943	4,947	4,872	650
16'	192" x 60"	M/TE1/19260	5,559	5,192	5,452	5,420	5,374	650
18'	216" x 60"	M/TE1/21660	6,044	5,677	5,961	5,892	5,875	650
20'	240" x 60"	M/TE1/24060	6,976	6,488	6,812	6,802	6,715	974
22'	264" x 60"	M/TE1/26460	7,461	6,972	7,321	7,275	7,216	974
24'	288" x 60"	M/TE1/28860	7,946	7,457	7,830	7,748	7,718	974
26'	312" x 60"	M/TE1/31260	8,431	7,942	8,339	8,220	8,220	1,299

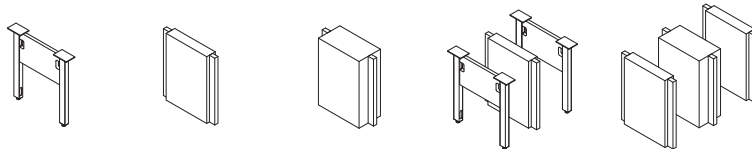

## how to order

## combination base configurations

please specify	example	table length	half panel/panel bases	panel/rectangle bases
1. model number & base code	M/TE1/16860/PR	12' - 18'	2 half panel & 1 panel	2 panel & 1 rectangle
2. wood color	DC	20' - 24'	2 half panel & 2 panel	2 panel & 2 rectangle
3. optional power/voice/data	O3	26'	3 half panel & 2 panel (alternating half panel/panel)	3 panel & 2 rectangle (alternating panel/rectangle)
notes:				
see page 7 for wood colors				
see page 9 for power/voice/data specifications				

# Simple™ conference table tops and bases

## arc boat tables



48" w x 39" w ends			half panel bases HB	panel bases PB	rectangle bases RB	combination half panel/ bases HP	combination panel/ rectangle bases PR	optional power/voice/data O3
length	size	model number	price	price	price	price	price	price
8'	96" x 48"	M/TF1/09648	\$ 2,692	\$ 2,462	\$ 2,585	\$ na	\$ na	\$ 325
10'	120" x 48"	M/TF1/12048	3,066	2,837	2,979	na	na	325
12'	144" x 48"	M/TF1/14448	3,899	3,555	3,733	3,801	3,679	650
14'	168" x 48"	M/TF1/16848	4,311	3,967	4,166	4,203	4,107	650
16'	192" x 48"	M/TF1/19248	4,724	4,380	4,599	4,606	4,533	650
18'	216" x 48"	M/TF1/21648	5,136	4,792	5,032	5,008	4,960	650
20'	240" x 48"	M/TF1/24048	5,969	5,510	5,786	5,819	5,704	974
22'	264" x 48"	M/TF1/26448	6,381	5,923	6,219	6,222	6,131	974
24'	288" x 48"	M/TF1/28848	6,794	6,335	6,652	6,624	6,557	974
26'	312" x 48"	M/TF1/31248	7,206	6,748	7,085	7,026	6,984	1,299

54" w x 42" w ends			half panel bases HB	panel bases PB	rectangle bases RB	combination half panel/ bases HP	combination panel/ rectangle bases PR	optional power/voice/data O3
length	size	model number	price	price	price	price	price	price
8'	96" x 54"	M/TF1/09654	\$ 2,985	\$ 2,741	\$ 2,877	\$ na	\$ na	\$ 325
10'	120" x 54"	M/TF1/12054	3,407	3,162	3,320	na	na	325
12'	144" x 54"	M/TF1/14454	4,317	3,950	4,148	4,209	4,089	650
14'	168" x 54"	M/TF1/16854	4,780	4,413	4,634	4,660	4,568	650
16'	192" x 54"	M/TF1/19254	5,242	4,876	5,119	5,111	5,046	650
18'	216" x 54"	M/TF1/21654	5,704	5,338	5,605	5,562	5,525	650
20'	240" x 54"	M/TF1/24054	6,615	6,126	6,432	6,450	6,341	974
22'	264" x 54"	M/TF1/26454	7,078	6,588	6,918	6,901	6,819	974
24'	288" x 54"	M/TF1/28854	7,540	7,051	7,403	7,351	7,298	974
26'	312" x 54"	M/TF1/31254	8,002	7,513	7,889	7,802	7,776	1,299

60" w x 44" w ends			half panel bases HB	panel bases PB	rectangle bases RB	combination half panel/ bases HP	combination panel/ rectangle bases PR	optional power/voice/data O3
length	size	model number	price	price	price	price	price	price
8'	96" x 60"	M/TF1/09660	\$ 3,212	\$ 2,967	\$ 3,116	\$ na	\$ na	\$ 325
10'	120" x 60"	M/TF1/12060	3,656	3,412	3,582	na	na	325
12'	144" x 60"	M/TF1/14460	4,589	4,222	4,433	4,474	4,370	650
14'	168" x 60"	M/TF1/16860	5,074	4,707	4,943	4,947	4,872	650
16'	192" x 60"	M/TF1/19260	5,559	5,192	5,452	5,420	5,374	650
18'	216" x 60"	M/TF1/21660	6,044	5,677	5,961	5,892	5,875	650
20'	240" x 60"	M/TF1/24060	6,976	6,488	6,812	6,802	6,715	974
22'	264" x 60"	M/TF1/26460	7,461	6,972	7,321	7,275	7,216	974
24'	288" x 60"	M/TF1/28860	7,946	7,457	7,830	7,748	7,718	974
26'	312" x 60"	M/TF1/31260	8,431	7,942	8,339	8,220	8,220	1,299

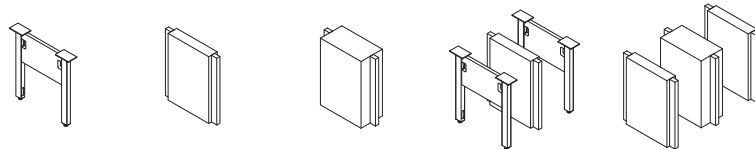

## how to order

please specify	example
1. model number & base code	M/TF1/16860/PR
2. wood color	DC
3. optional power/voice/data	O3

notes:

see page 7 for wood colors

see page 9 for power/voice/data specifications

## combination base configurations

table length	half panel/panel bases	panel/rectangle bases
12' - 18'	2 half panel & 1 panel	2 panel & 1 rectangle
20' - 24'	2 half panel & 2 panel	2 panel & 2 rectangle
26'	3 half panel & 2 panel (alternating half panel/panel)	3 panel & 2 rectangle (alternating panel/rectangle)

# Simple™ conference table tops and bases

## racetrack tables



48" wide			half drum bases HB	drum bases PB	combination half drum/ rectangle bases HP	optional power/ voice/data O3
length	size	model number	price	price	price	price
8'	96" x 48"	M/TG1/09648	\$ 2,536	\$ 2,614	\$ na	\$ 325
10'	120" x 48"	M/TG1/12048	2,882	2,971	na	325
12'	144" x 48"	M/TG1/14448	na	3,790	4,056	650
14'	168" x 48"	M/TG1/16848	na	4,183	4,527	650
16'	192" x 48"	M/TG1/19248	na	4,575	4,998	650
18'	216" x 48"	M/TG1/21648	na	4,968	5,468	650
20'	240" x 48"	M/TG1/24048	na	5,786	6,288	974
22'	264" x 48"	M/TG1/26448	na	6,179	6,759	974
24'	288" x 48"	M/TG1/28848	na	6,572	7,229	974
26'	312" x 48"	M/TG1/31248	na	6,965	7,700	1,299

54" wide			price	price	price	price
8'	96" x 54"	M/TG1/09654	\$ 2,810	\$ 2,897	\$ na	\$ 325
10'	120" x 54"	M/TG1/12054	3,200	3,299	na	325
12'	144" x 54"	M/TG1/14454	na	4,193	4,508	650
14'	168" x 54"	M/TG1/16854	na	4,634	5,035	650
16'	192" x 54"	M/TG1/19254	na	5,074	5,563	650
18'	216" x 54"	M/TG1/21654	na	5,514	6,091	650
20'	240" x 54"	M/TG1/24054	na	6,409	6,990	974
22'	264" x 54"	M/TG1/26454	na	6,849	7,518	974
24'	288" x 54"	M/TG1/28854	na	7,289	8,046	974
26'	312" x 54"	M/TG1/31254	na	7,730	8,574	1,299

60" wide			price	price	price	price
8'	96" x 60"	M/TG1/09660	\$ 3,020	\$ 3,113	\$ na	\$ 325
10'	120" x 60"	M/TG1/12060	3,430	3,536	na	325
12'	144" x 60"	M/TG1/14460	na	4,452	4,818	650
14'	168" x 60"	M/TG1/16860	na	4,914	5,371	650
16'	192" x 60"	M/TG1/19260	na	5,375	5,925	650
18'	216" x 60"	M/TG1/21660	na	5,837	6,478	650
20'	240" x 60"	M/TG1/24060	na	6,753	7,403	974
22'	264" x 60"	M/TG1/26460	na	7,215	7,956	974
24'	288" x 60"	M/TG1/28860	na	7,676	8,509	974
26'	312" x 60"	M/TG1/31260	na	8,138	9,063	1,299

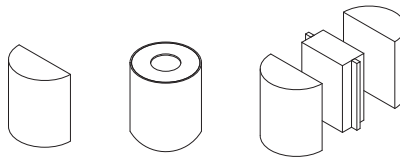

## how to order

## combination base configurations

please specify	example	table length	half drum/rectangle bases
1. model number & base code	M/TG1/16860/DB	12' - 18'	2 half drum & 1 rectangle
2. wood color	DC	20' - 24'	2 half drum & 2 rectangle
3. optional power/voice/data	O3	26'	2 half drum & 1 rectangle

notes:

see page 7 for wood colors

see page 9 for power/voice/data specifications

# Simple™ conference table tops and bases

## viewpoint tables



ends are 30" w and 60" w			half panel bases HB	panel bases PB	rectangle bases RB	combination half panel/ bases HP	combination panel/ rectangle bases PR	optional power/ voice/data O3
length	size	model number	price	price	price	price	price	price
8'	96" x 60"	M/TH1/09660	\$ 3,058	\$ 2,821	\$ 2,998	\$ na	\$ na	\$ 325
10'	120" x 60"	M/TH1/12060	3,558	3,311	3,487	na	na	325
12'	144" x 60"	M/TH1/14460	4,667	4,315	4,575	4,570	4,480	650
14'	168" x 60"	M/TH1/16860	5,300	4,936	5,196	5,203	5,101	650
16'	192" x 60"	M/TH1/19260	5,793	5,419	5,679	5,695	5,584	650
18'	216" x 60"	M/TH1/21660	6,438	6,051	6,311	6,341	6,216	650
20'	240" x 60"	M/TH1/24060	7,334	6,843	7,190	7,304	7,161	974

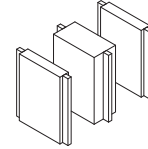
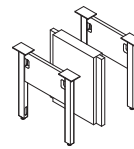
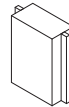
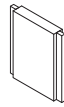
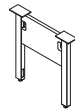

## how to order

## combination base configurations

please specify	example	table length	half panel/panel bases	panel/rectangle bases
1. model number & base code	M/TH1/16860/PR	12' - 18'	2 half panel & 1 panel	2 panel & 1 rectangle
2. wood color	DC	20'	2 half panel & 2 panel	2 panel & 2 rectangle
3. optional power/voice/data	O3			

notes:

see page 7 for wood colors

see page 9 for power/voice/data specifications

## storage credenzas/e-credenzas units require finishing top – ends are color coat

single wide cabinet  
with one door and one shelf

16w 16d 30h M/CSA/01616 \$ 656  
16w 22d 30h M/CSB/01622 \$ 756

door hinged right -R

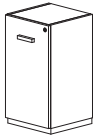

double wide cabinet  
with two doors and one shelf

32w 16d 30h M/CSA/03216 \$1014  
32w 22d 30h M/CSB/03222 \$1169

equipment rack ready with  
vented bottom/back -E



double wide e-cabinet equipment  
rack ready with one door one vented  
door and vented back

32w 22d 30h M/CSC/03222 \$1054

vented door right -R

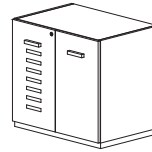

cabinet with box/recycle drawer  
and single door and shelf

32w 16d 30h M/CSD/03216 \$1425  
32w 22d 30h M/CSE/03222 \$1577

door hinged right -R

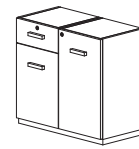

## storage/display cabinets units require finishing top – ends are color coat

double wide cabinet  
with two wood doors and  
three shelves

32w 16d 66h M/MDP/03216 \$1471  
32w 22d 66h M/MDP/03222 \$1720

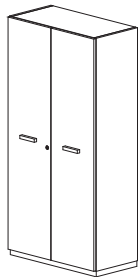

double wide cabinet  
with open bookcase and  
three shelves

32w 16d 66h M/MDQ/03216 \$ 873  
32w 22d 66h M/MDQ/03222 \$1122

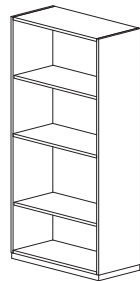

double wide cabinet  
with two glass doors and  
three clear glass shelves

32w 16d 66h M/MDW/03216 \$1709  
32w 22d 66h M/MDW/03222 \$2018

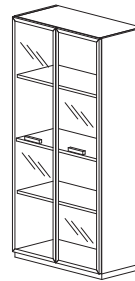

single wide cabinet  
with wood door and  
four shelves

16w 16d 78h M/CSD/03216 \$1060  
16w 22d 78h M/CSE/03222 \$1239

door hinged right -R



## finishing tops

wood

16w 16d .75h M/WFT/01616 \$ 130  
32w 16d .75h M/WFT/03222 \$ 172  
48w 16d .75h M/WFT/04816 \$ 211  
64w 16d .75h M/WFT/06416 \$ 252

16w 22d .75h M/WFT/01622 \$ 146  
32w 22d .75h M/WFT/03222 \$ 198  
48w 22d .75h M/WFT/04822 \$ 250  
64w 22d .75h M/WFT/06422 \$ 302  
80w 22d .75h M/WFT/08022 \$ 354  
96w 22d .75h M/WFT/09622 \$ 406



etched glass 3/8" h  
with 3/8" h colorcoat plinth

16w 16d .75h M/EGT/01616 \$ 221  
32w 16d .75h M/EGT/03216 \$ 389  
48w 16d .75h M/EGT/04816 \$ 556  
64w 16d .75h M/EGT/06416 \$ 724

16w 22d .75h M/EGT/01622 \$ 231  
32w 22d .75h M/EGT/03222 \$ 461  
48w 22d .75h M/EGT/04822 \$ 692  
64w 22d .75h M/EGT/06422 \$ 923



## buffet shelf option for credenzas

etched glass shelf 1/2" h  
with 3" 1/2" h colorcoat plinth  
requires wood finishing top

16w 8d 4h M/BST/01608 \$ 214  
32w 8d 4h M/BST/03208 \$ 331  
48w 8d 4h M/BST/04808 \$ 448  
64w 8d 4h M/BST/06408 \$ 565



buffet credenzas units require finishing top – ends are color coat

double wide cabinet  
with open bookcase and one shelf

32w 16d 30h M/BKG/03216 \$ 623  
32w 22d 30h M/BKC/03222 \$ 774

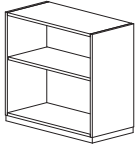

double wide buffet cabinet with  
pull out service shelf, two doors  
and one shelf

32w 16d 35h M/CSA/03216 \$1315  
32w 22d 35h M/CSB/03222 \$1477



buffet cabinet with pull out  
service shelf, utensil/box/recycle  
drawers, door and shelf

32w 16d 35h M/CBC/03216 \$1694  
32w 22d 35h M/CBD/03222 \$1894  
drawers right -R

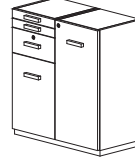

single wide cabinet  
with etched glass door and  
four clear glass shelves

16w 16d 78h M/MDB/01616 \$1202  
16w 22d 78h M/MDB/01622 \$1385

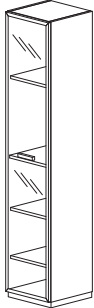

double wide cabinet  
with two wood doors and  
four shelves

32w 16d 78h M/MDI/03216 \$1645  
32w 22d 78h M/MDI/03222 \$1933

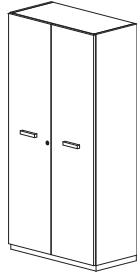

double wide cabinet  
with open bookcase and  
four shelves

32w 16d 78h M/MDF/03216 \$ 978  
32w 22d 78h M/MDF/03222 \$1265

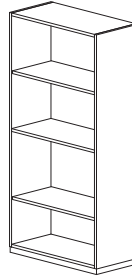

double wide cabinet  
with etched glass doors and  
four clear glass shelves

32w 16d 78h M/CDG/03216 \$2020  
32w 22d 78h M/CDG/03222 \$2385

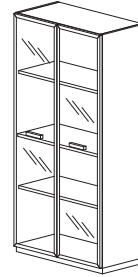

how to order

please specify

example

1. cabinet(s) from left to right

a. cabinet

M/CSD/01616

b. cabinet

M/CSA/01616

2. finishing top

M/WFT/01616

3. wood color

DC

notes:

see page 7 for wood colors and model numbers

low credenzas/e-credenzas ends are color coat

single wide cabinet ends  
open shelving middle

64w 16d 27h M/CNA/06416 \$1865  
64w 22d 27h M/CNA/06422 \$2072

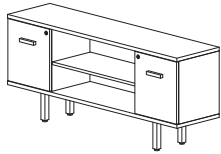

double wide cabinet  
with two doors and one shelf

72w 16d 27h M/CNG/07216 \$1942  
72w 22d 27h M/CNG/07222 \$2148

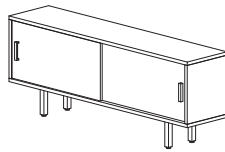

wall mount buffet

wall mount wood serving cabinet

64w 10d 9h M/WMB/06409 \$ 483



wall mount for flat screen monitor

vertical grain wood mounting face  
3/4" d with 2" d cabinet behind for wire  
management

48w 8d 30h M/MPM/04808 \$ 520  
64w 8d 42h M/MPM/06408 \$ 717

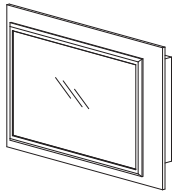

porcelain boards

porcelain enamel writing surface  
with colorcoat top and bottom trim  
and wood sides

72w 2.5d 48h M/SYS/07248 \$ 853  
96w 2.5d 48h M/SYS/09648 \$1065

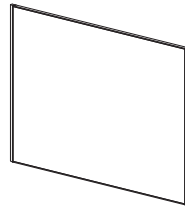

**hospitality cart** ends are color coat

double wide cabinet with pull out serving shelf, bumper guard on bottom and four casters

32w 22d 36h M/HOC/03236 \$1484



**lectern** ends are color coat

2 legs front, 2 casters back, raised etched glass water glass shelf, adjustable reading shelf, bumper guard on bottom

32w 22d 48h M/LEC/04832 \$1529

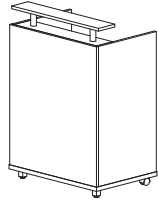

**visual boards**

wood doors with colorcoat trim top and porcelain enamel writing surface with pull down projection screen

48w 3.5d 49h M/VIS/04849 \$ 828

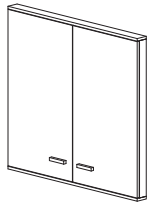

wood doors with colorcoat trim top and bottom porcelain enamel writing surface with pull down projection screen

72w 3.5d 49h M/VIS/07249 \$1006

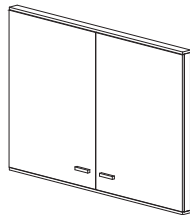

**how to order**

**please specify**

- 1. model
- 2. wood color

notes:

see page 7 for wood colors and model numbers

**example**

M/VIS/07249  
DC

storage credenzas ends are color coat

single wide cabinet left  
double side cabinet right

48w 16d 30h M/CSA/04816 \$1579  
48w 22d 30h M/CSB/04822 \$1832

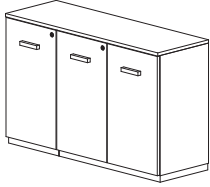

single wide cabinet left and right  
box drawer/recycle bin cabinet middle

48w 16d 30h M/CSD/04816 \$1990  
48w 22d 30h M/CSE/04822 \$2239

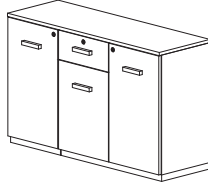

single wide cabinet left, double wide  
cabinet right with vented door and back  
for rack equipment

48w 22d 30h M/CSC/04822 \$1717

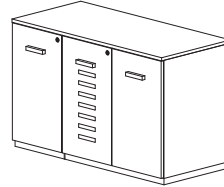

buffet credenzas ends are color coat

2 double wide cabinets with  
4h etched glass buffet shelf

64w 16d 34h M/CGA/06416 \$2502  
64w 22d 34h M/CGB/06422 \$2809

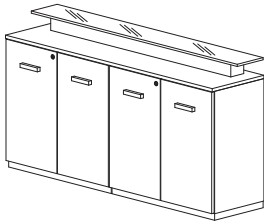

2 double wide cabinets with  
2 pull out serving shelves

64w 16d 35h M/CBA/06416 \$2539  
64w 22d 35h M/CBB/06422 \$2861

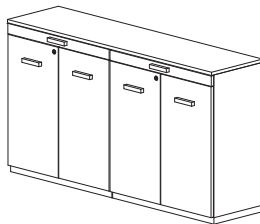

utensil drawer/box/drawer/recycle bin cabinet  
single wide cabinet double wide cabinet and  
1 pull out serving shelf

64w 16d 35h M/CBC/06416 \$2919  
64w 22d 35h M/CBD/06422 \$3277

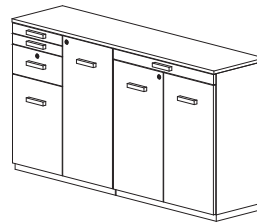

mediawalls ends are color coat

mounts for flat screen monitor, 2 single wide  
cabinets with wood doors, 2 double wide  
cabinets with etched glass shelf

96w 16d 78h M/MDR/09616 \$5141

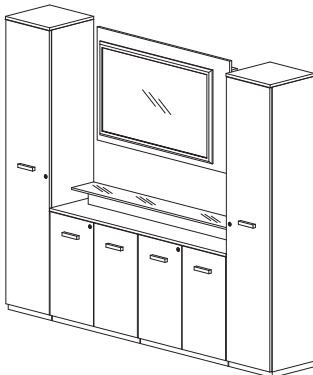

mount for flat screen monitor, 2 single wide  
cabinets with etched glass doors and clear glass shelves  
low credenza with 2 sliding wood doors

104w 22d 78h M/MDR/10422 \$5529

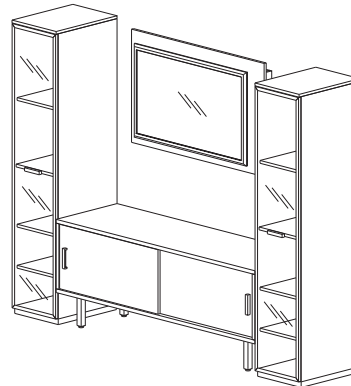

2 double wide cabinets, 22d version  
may be specified as e-credenza vented  
back and bottom for rack mount

64w 16d 30h M/CSA/06416 \$1937  
64w 22d 30h M/CSB/06422 \$2244

e-credenza -e

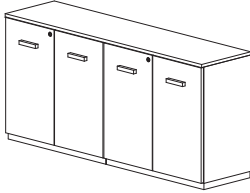

2 double wide cabinets  
with etched glass top

64w 16d 30h M/CGC/06416 \$2409  
64w 22d 30h M/CGD/06422 \$2866

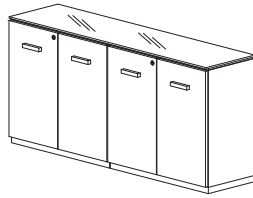

box drawer/recycle bin cabinet  
single wide cabinet  
double wide cabinet

64w 16d 30h M/CSD/06416 \$2348  
64w 22d 30h M/CSE/06422 \$2652

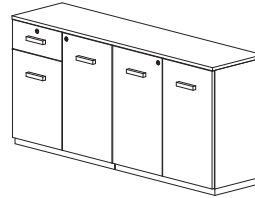

cabinet with box/recycle drawer  
and single door and shelf

32w 22d 30h M/CSC/06422 \$2130

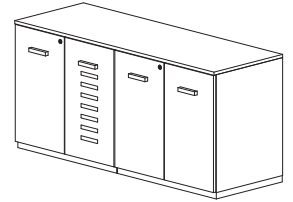

### storage/display cabinets ends are color coat

double wide cabinet with wood doors  
double wide display cabinet

64w 16d 66h M/MDX/06416 \$2254  
64w 22d 66h M/MDX/06422 \$2749

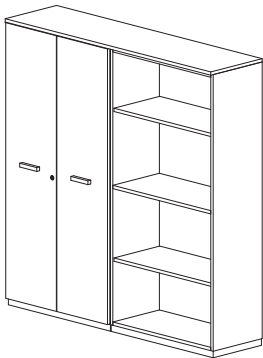

double wide cabinet with wood doors  
double wide cabinet with etched  
glass doors

64w 16d 66h M/MDZ/06416 \$3357  
64w 22d 66h M/MDZ/06422 \$3852

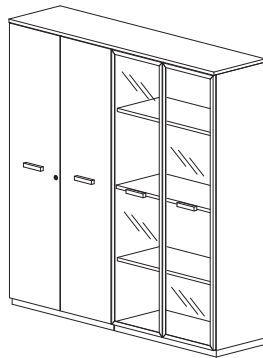

### how to order

please specify

1. model
2. wood color

notes:

see page 7 for wood colors and model numbers

example

M/MDZ/06416  
DC

NEVERS®

**Defining the Meeting Room™**

14125 21st Avenue North, Minneapolis, MN 55447

P: 763.553.1632 | 800.242.2443 | F: 763.553.1770 | 800.258.5591

[www.nevers.com](http://www.nevers.com)